

edilportale® TOUR 2016

Efficienza energetica e comfort abitativo
Tecnologie non invasive e sicurezza
Sostenibilità economica e ambientale

in collaborazione con

VELUX®



Ancona, 22 Marzo 2016

Alubel, sistemi per la riqualificazione degli edifici

Arch. Matteo Minelli

PRIMA



DOPO





DATI TECNICI

- *S. 25 mm*
- *H. 500 mm*
- *L. a misura*

MATERIALI

- *Alluminio
preverniciato*
- *Poliuretano espanso
ad alta densità*



PRINCIPALI CARATTERISTICHE

- FINITURA LISCIA
- FISSAGGIO NASCOSTO
- AMPIA SCELTA DI COLORI
- FACILE DA INSTALLARE
- LEGGERO E MANEGGEVOLE
- IDEALE IN CASO DI RIQUALIFICAZIONE EDILIZIA



LAVORAZIONI

PANEL EDGING

CHIUSURA LATERALE



TAGLIO A 45°

REALIZZAZIONE ANGOLO



ACCESSORI

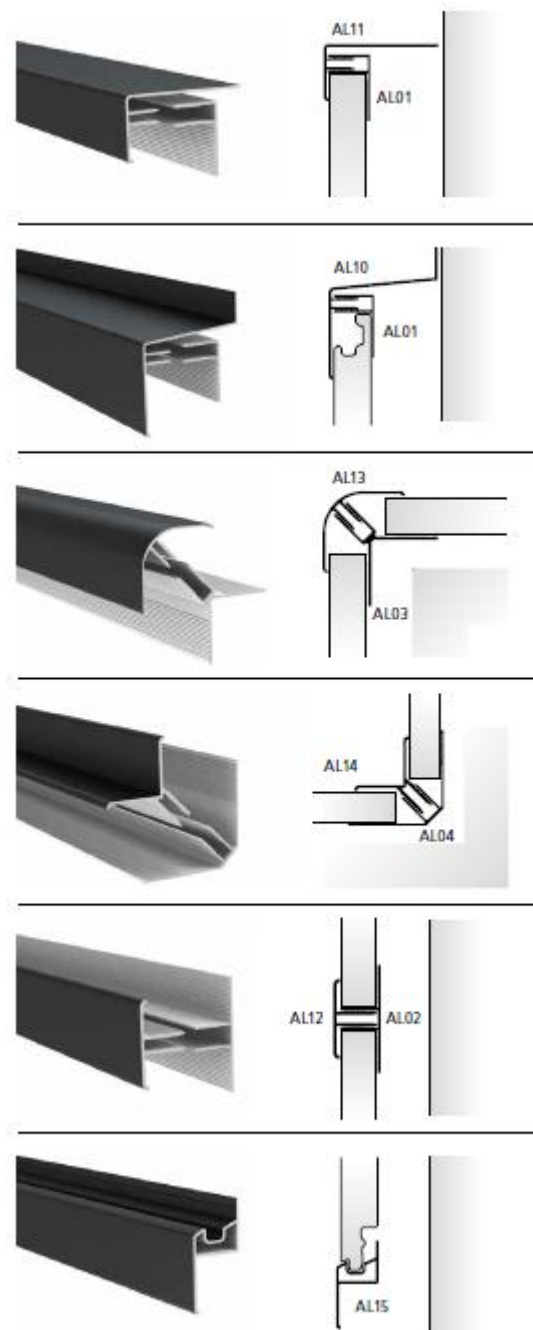
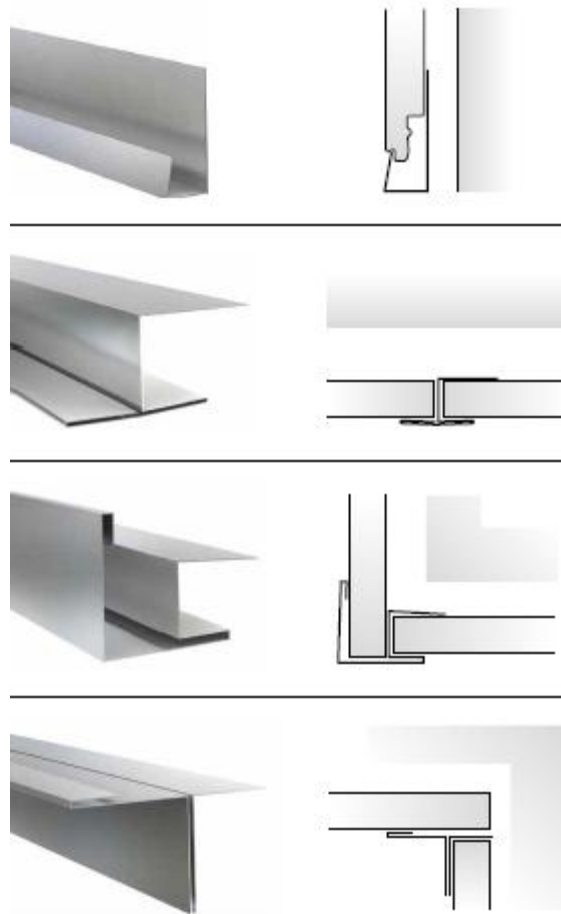

Case history

Riqualificazione stabilimento produttivo
CSO Italia – Scandicci (FI)

- **Progettista:**
Arch. Silvia Nanni - San Casciano Val di Pesa (FI)
- **Ditta installatrice:**
Coperture Cappelletti Daniele e Figli S.R.L. di Prato (PO)



DEMOLIZIONE ?

NO, GRAZIE.

PERCHE' ?

- ECCESSIVA BUROCRAZIA
- BASSA SOSTENIBILITA'

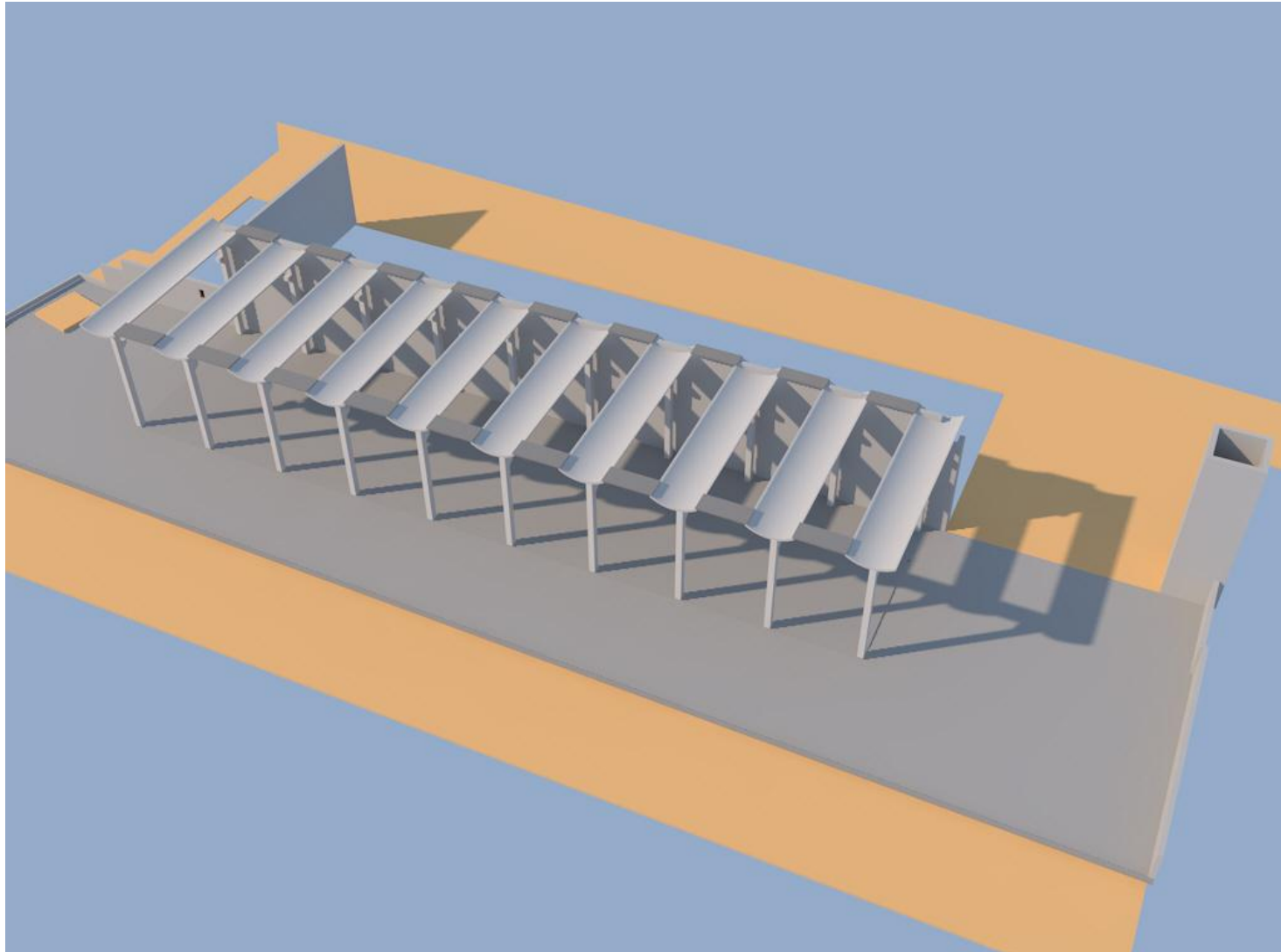

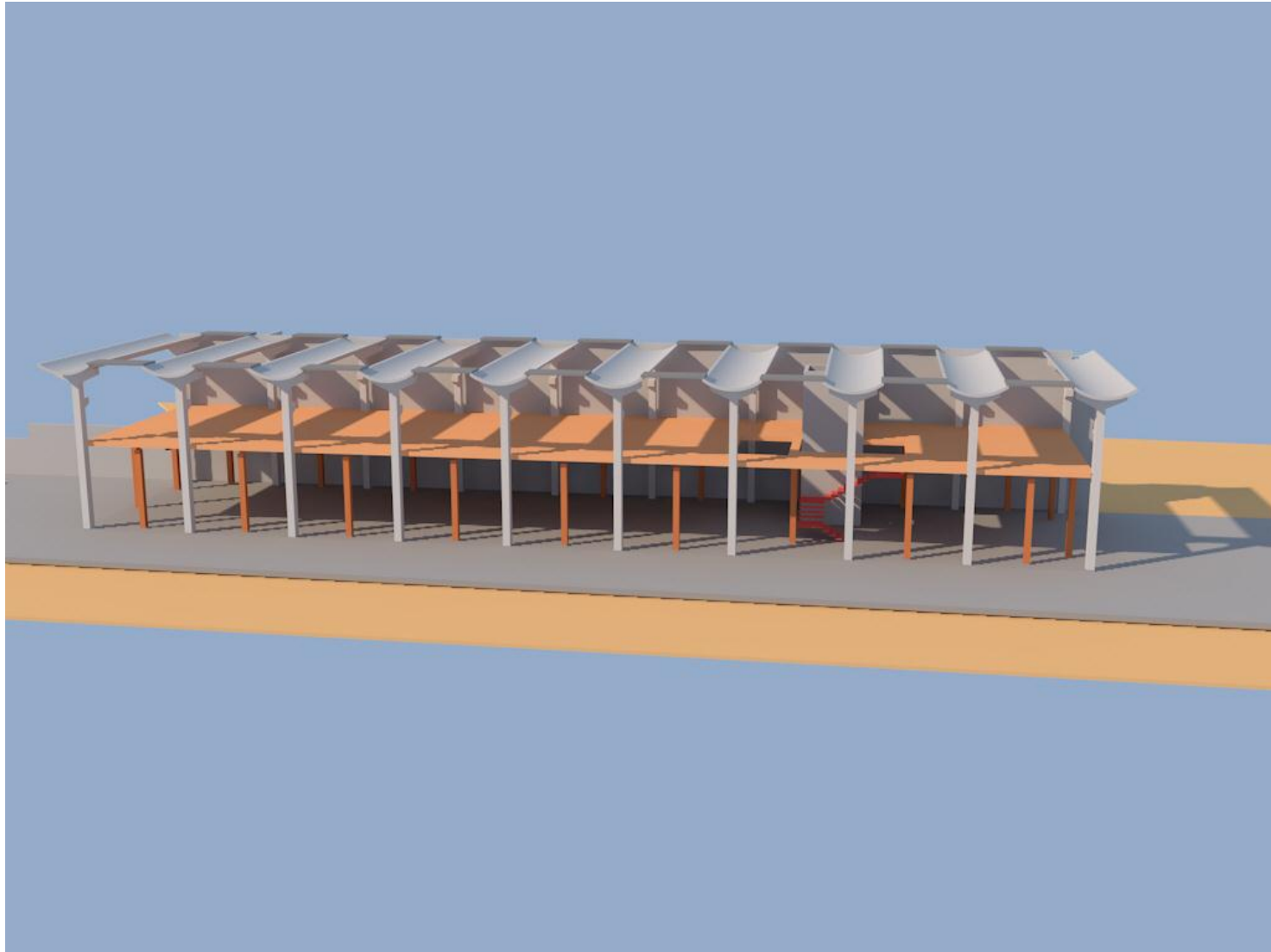



CARATTERISTICHE TERMICHE/IGROMETRICHE DEI COMPONENTI OPACI DELL'INVOLUCRO EDILIZIO

TIPO DI STRUTTURA *Copertura piana pannello sandwich*
cod 630 SOF

Massa [kg/m ²]	19,6	Capacità [kJ/m ² K]	12,7	Type Ashrae			1		
N	Descrizione strato (dall'interno verso l'esterno)	s (m)	λ (W/mK)	C (W/m ² K)	ρ (kg/m ³)	δa 10 ¹² (kg/m ² Pa)	δu 10 ¹² (kg/m ² Pa)	R (m ² K/W)	
1	Lamiera	0,0010	17,000	17000,00	8000	1,0000	1,0000	0,000	
2	Poliuretano espanso a celle chiuse da 30 Kg/mc in lastre da blocchi espansi in continuo per strutture orizzontali	0,1200	0,032	0,27	30	0,2000	0,2000	3,750	
3	Lamiera	0,0010	17,000	17000,00	8000	1,0000	1,0000	0,000	
SPESSORE TOTALE [m]		0,1220							

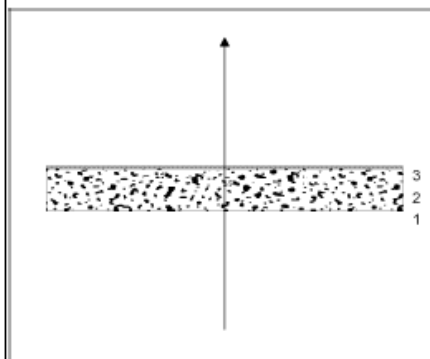

Conduttanza unitaria superficie interna	9	Resistenza unitaria superficie interna	0,107
---	---	--	-------

Conduttanza unitaria superficie esterna	23	Resistenza unitaria superficie esterna	0,043
---	----	--	-------

TRASMITTANZA TOTALE[W/m ² K]	0,256	RESISTENZA TERMICA TOTALE[m ² K/W]	3,900
---	-------	---	-------

**PROGETTO
COPERTURA**

VERIFICA IGROMETRICA — CONDIZIONI AL CONTORNO

CONDIZIONE	Ti(°C)	Pi(Pa)	Te(°C)	Pe(Pa)
INVERNALE: gennaio	20,0	1520	0,0	549
ESTIVA: agosto	24,0	2387	24,0	2089

<input checked="" type="checkbox"/>	La struttura non è soggetta a fenomeni di condensa interstiziale; la differenza minima di pressione tra quella di saturazione e quella reale è pari a [Pa]	70
<input type="checkbox"/>	La struttura è soggetta a fenomeni di condensa; la quantità stagionale di condensato è pari a [kg/m ²] (ammissibile ed evaporabile nella stagione estiva)	
<input checked="" type="checkbox"/>	La struttura non è soggetta a fenomeni di condensa superficiale; la differenza minima di pressione tra quella di saturazione e quella reale è pari a [Pa]	741

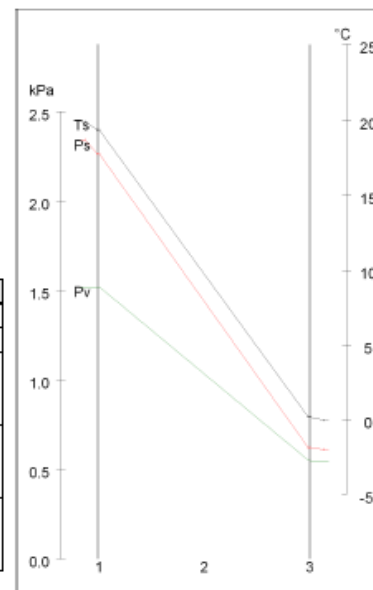

EASYWAND

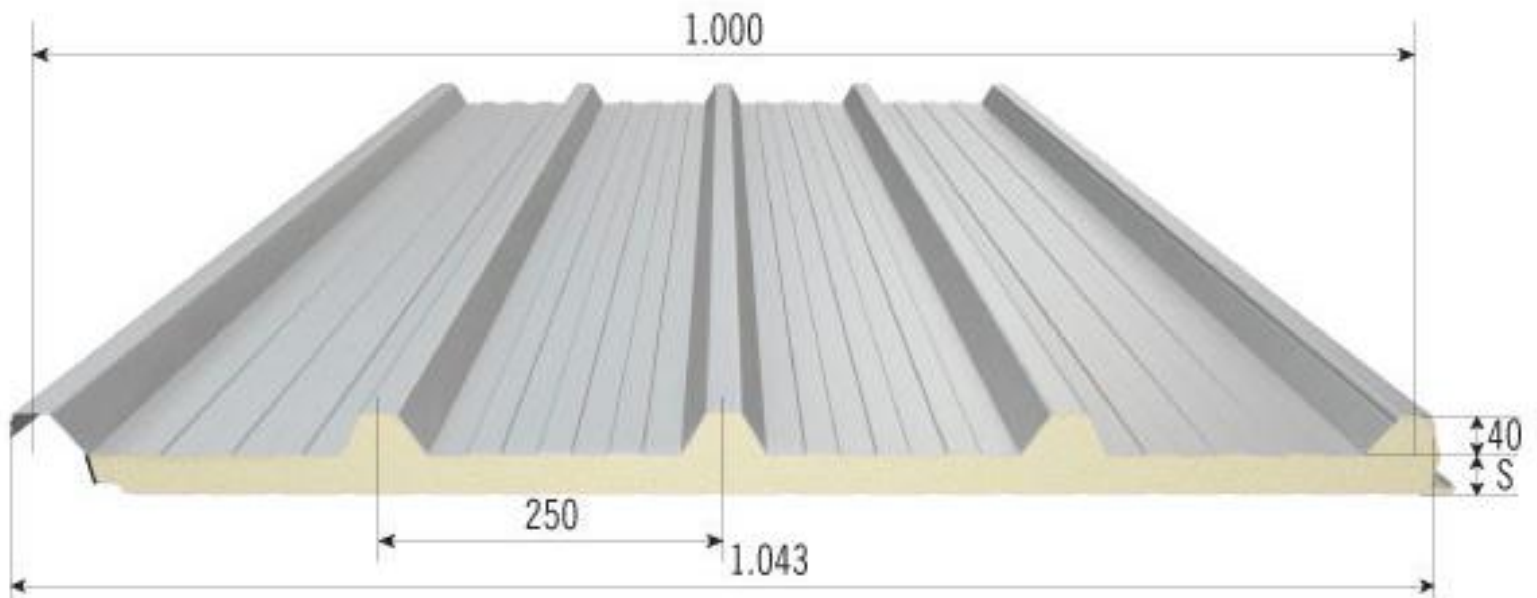











TIPO DI STRUTTURA *Muratura isolata a cappotto*
cod 154 P.E

Massa [kg/m ²]	464.5	Capacità [kJ/m ² K]	390.8	Type Ashrae	33			
N	Descrizione strato (dall'interno verso l'esterno)	s (m)	λ (W/mK)	C (W/m ² K)	ρ (kg/m ³)	δa 10 ¹² (kg/m ² Pa)	δu 10 ¹² (kg/m ² Pa)	R (m ² K/W)
1	Laterizi per pareti esterne (mattono pieno)	0,2500	0,800	3,20	1800	20,8400	20,8400	0,312
2	Polistirene espanso	0,1000	0,031	0,31	15	10,0000	10,0000	3,228
3	Intonaco plastico per isolamenti a cappotto (permeabilità garantita)	0,0100	0,300	30,00	1300	6,2500	6,2500	0,033
SPESSORE TOTALE [m]		0,3600						

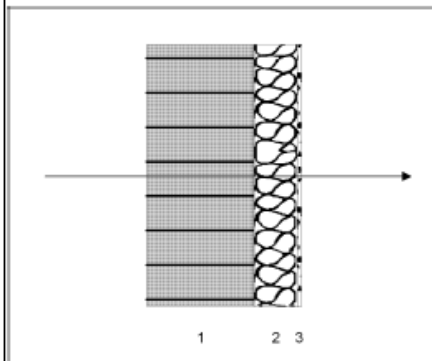

Conduttanza unitaria superficie interna	8	Resistenza unitaria superficie interna	0,123
---	---	--	-------

Conduttanza unitaria superficie esterna	23	Resistenza unitaria superficie esterna	0,043
---	----	--	-------

TRASMITTANZA TOTALE [W/m ² K]	0,268	RESISTENZA TERMICA TOTALE [m ² K/W]	3,738
--	-------	--	-------

PROGETTO FACCIATA

VERIFICA IGROMETRICA — CONDIZIONI AL CONTORNO

CONDIZIONE	Ti(°C)	Pi(Pa)	Te(°C)	Pe(Pa)
INVERNALE: gennaio	20.0	1520	0.0	549
ESTIVA: agosto	20.0	1870	20.0	1637
<input checked="" type="checkbox"/> La struttura non è soggetta a fenomeni di condensa interstiziale; la differenza minima di pressione tra quella di saturazione e quella reale è pari a [Pa]				14
<input type="checkbox"/> La struttura è soggetta a fenomeni di condensa; la quantità stagionale di condensato è pari a [kg/m ²] (ammissibile ed evaporabile nella stagione estiva)				
<input checked="" type="checkbox"/> La struttura non è soggetta a fenomeni di condensa superficiale; la differenza minima di pressione tra quella di saturazione e quella reale è pari a [Pa]				725

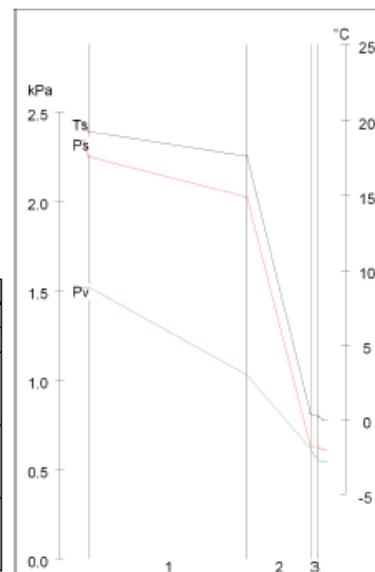

EASYWAND

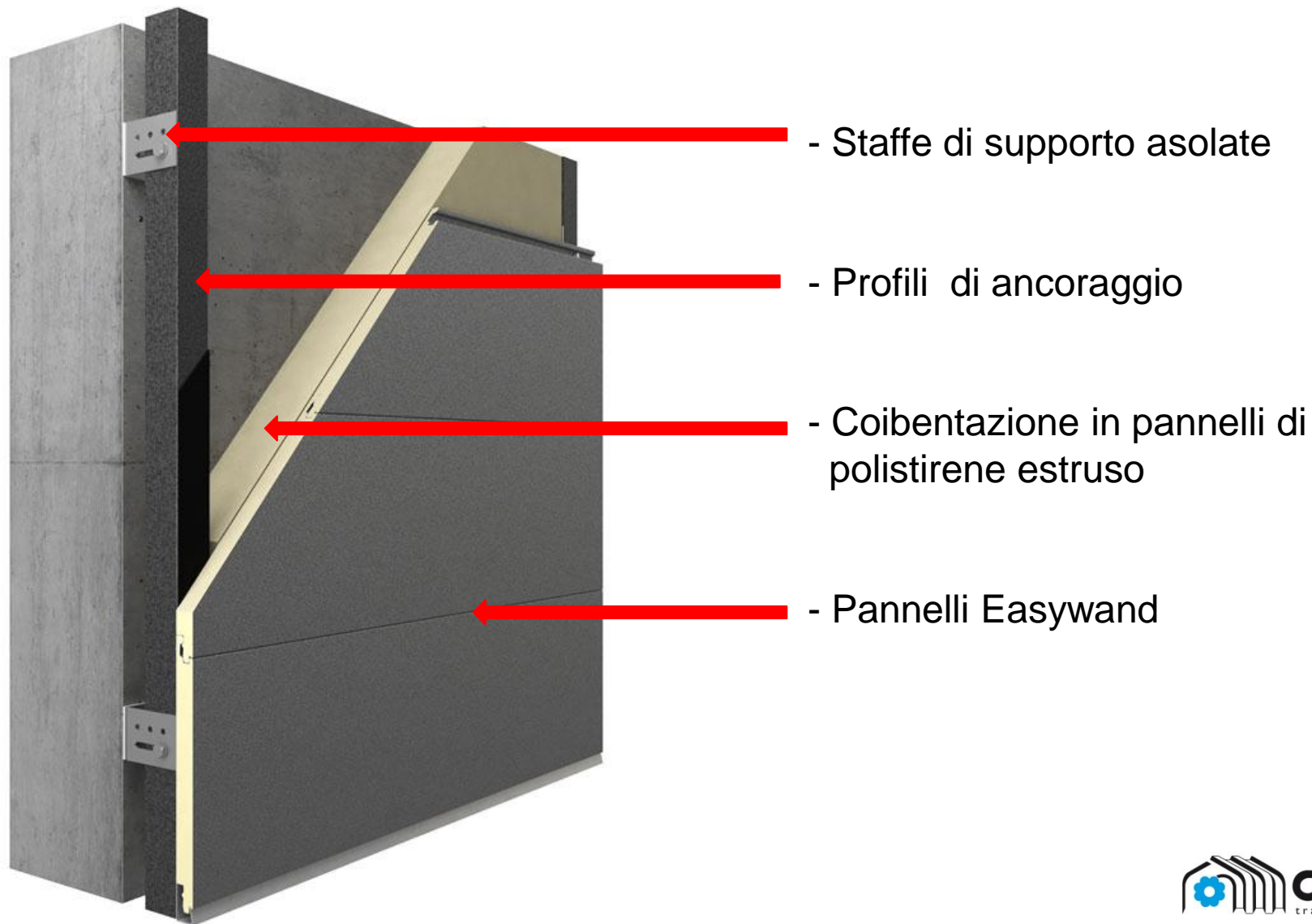





EASYWAND















PRIMA



DOPO



PRIMA



DOPO



**GRAZIE E
BUON LAVORO !**

